

RECARO

A DRIVE UNLIKE ANY OTHER

RECARO aftermarket car seats





WE PUT YOUR SENSES IN THE DRIVING SEAT.



Wilhelm Reutter founded his body shop in 1906. Ever since, we've been obsessed with custom mobility, and Reutter's passion lives on in the first two letters of our brand as well as in everything we do. We're all about making driving safer, more comfortable and more controlled – a driving experience that you can really feel. We put people first. Every time. We're equally obsessed with motorsport. Whatever record you broke yesterday, you aspire to beat it today. That's why we're constantly looking for ways for you to shave a little time off your next lap – safely. Winning is one thing. But to be a champion, you need to keep learning and developing.

Our seats are more than just a set of components. They're made of innovation, quality, premium materials, craftsmanship and a serious passion for cars. From the ultimate in comfort and ergonomics to uncompromising sporting flair, our products are as diverse and exacting as the individuals who buy them. And always in the quality you expect from RECARO. Choose cutting-edge performance that puts you in the driving seat.

Enjoy the ride!



SIMPLY THE BEST. SINCE 1995.

Since 1995, we have regularly been honored in the readers' polls of the best-known automotive magazines. And more than successfully! RECARO is the number one seat brand among readers. Thank you for your trust!

* Since 1995, RECARO has been named best seat brand 72 times, including 5 times in 2023. Thank you!



FORGING INNOVATION SINCE 1906.

For over 115 years, our products have combined innovation, quality and craftsmanship. Every detail counts, right down to the last millimeter.

RECARO has been setting new standards for over 60 years. Our roots go way back to the Stuttgarter Carosserie- u. Radfabrik founded in 1906 by master saddler Wilhelm Reutter. The company developed and produced car bodies for all major manufacturers, including the interior fittings, so seat specialization was the next logical step. In 1963, REutter CAROserie became seat specialist RECARO.

In 1965, RECARO unveiled its "sports seat," the very first of its kind. The automotive seating revolution had begun! Just two years later, the RECARO rallye became the first road-legal shell seat. The success story continued with countless pioneering milestones in comfort, safety and lightweight construction.

Innovation is second nature to us, and RECARO Automotive dominates the car seating industry to this day. What's more, we're already shaping its future. The RECARO seats of tomorrow will take the unique RECARO driving experience to a new level on both the road and the race track.

Did you know that in 1950, the body and interior of the first Porsche 356 sports car was built at the first Reutter plant? In 1963, Reutter sold its second bodywork plant in Stuttgart's Zuffenhausen district to Porsche, and began focusing on its core business of seating under a new name – RECARO.



Our first ads under a new name.

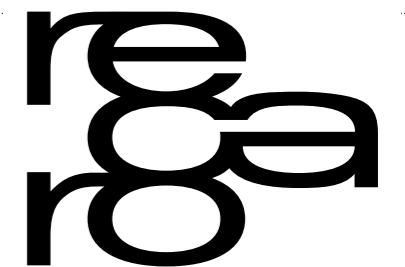

Founded in 1963, the new "car seating company" emerged under the name RECARO, a play on words combining REutter and CAROserie, the old German word for car body.

In 1965, RECARO unveiled its *sports seat* at the International Motor Show in Frankfurt, revolutionizing car seating. The new model was an instant hit. No wonder, as even then, it epitomized a fusion of functionality, ergonomics and esthetics that RECARO now calls "Ingenious Design." Continuously developed ever since, this RECARO DNA characterizes every single one of our products.



1906

Master saddler Wilhelm Reutter starts on the development and production of car bodies, interior fittings and vehicle seats for automobiles, both in custom production and small batches, at his "Stuttgarter Carosserie-u. Radfabrik" body plant.



1920s/1930s

The company produces car bodies and interior fittings for all major car manufacturers. Precursors and prototypes of the Volkswagen (later Beetle) are also manufactured by Reutter on behalf of the Porsche design studio.



1950s

Car bodies, interior fittings and seats for the Porsche 356 go into production at Reutter in Stuttgart. By 1965, the company has built around 60,000 vehicles. Development and subsequent production of reclining seat mechanisms begins.



1965

Launch of the RECARO **sports seat**. The world's first retrofit seat for automobiles is characterized by its revolutionary foam upholstery and distinctive side bolsters.



1967

The "RECARO **shell seat**" is RECARO's first road-legal full shell seat. It raises the bar in safety, lightweight construction and comfort with a body-hugging seat shell, adjustment options and foam upholstery.

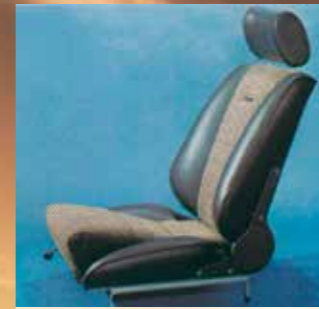

1969

The previous RECARO sports seat is renamed the "RECARO **Idealsitz**." At the same time, RECARO introduces a new trademark, which has remained unchanged to this day.



1971

A world first: RECARO unveils the first vehicle seat with an **integrated seat belt** – the RECARO safety seat.



1973

RECARO is the first manufacturer to offer the **anti-submarining** seat upholstery guide, which prevents the occupant from slipping under the belt in the event of an accident. Also making its car seat premiere is RECARO's **extendable seat cushion**, an added comfort feature for tall drivers.



1974

For the world elite in touring car motorsport, RECARO launches its first **racing seat** with a super sturdy double shell made of the fiber-reinforced composite Kevlar – for top-level safety and low weight (6.5 kg).



1977

The new RECARO Airmatic® pneumatic **lumbar support**, **adjustable side bolsters** on the seat cushion and backrest and RECARO's first **electrically adjustable backrest** significantly improve adaptability to individual requirements.



1977

Acoustic comfort: under the name RECAROofonie, the company launches a seat with **stereo loudspeakers** integrated in the headrest.



1984

A seat that remembers. The RECARO CSE comfort seat is the first to have a **memory function**.



1989

Innovation in novel materials: The RECARO A8 sports seat comes with a back shell made of **plastic**.



1990

Cool cabbies: The company introduces the RECARO taxi seat, the first **car seat with ventilation** (RECARO Vent System®).



1995

The world's first racing shell with **head protection**. RECARO's new Pro Racer racing shell revolutionizes safety standards in professional motorsport.



2004

RECARO unveils the **world's first retrofit universal side airbag seat** with ABE for different vehicle models.



2005

RECARO becomes the world's first seat manufacturer to revolutionize seating design with its new **lightweight composite shell**.



2005

RECARO launches the first **full shell with ABE** (German general type approval) on the market.



2013

RECARO Automotive unveils the P 1300 GT, the first **racing shell with fore-aft adjustment**, combining top-level safety with tailored comfort.



2019

The RECARO Podium is the only retrofit shell seat on the market that is approved for use on public roads (**ABE general type approval**) and has **FIA homologation**. Awarded the **AGR seal of quality**.



2020

The new versions of our classic seats, the **RECARO Classic Pole Position (ABE)** and the **Classic LX and LS**, turn classic vehicle interiors into pictures of perfection.



2021

From the car to the desk: exclusive Performance and Classic swivel chairs with original car seats: **RECARO Classic LX Star**, **Cross Sportster CS Star** and **RECARO Speed Star** for the home and workplace.



2023

The first model in RECARO's new generation of sports seats: **the first all-electric 8-way aftermarket sports seat: RECARO Sport C**. Awarded the **AGR seal of quality**. **1963 – 2023: We're celebrating 60 years of the RECARO brand.**



2024

For road and track: The RECARO Podium in **glass fiber reinforced plastic (GFRP)**.

EVERY INCH LUXURIOUS.

Hand-picked surfaces. Premium carbon. Exclusive leather. Perfect stitching that draws the eye along the side contour. A RECARO seat fuses style, superb materials and outstanding craftsmanship for unparalleled quality.

Only the perfect combination of color, form and manufacture meets RECARO's premium standards. It really is as comfortable as it looks! Ultra-light carbon, cutting-edge composites, and high-end foams and textiles complete our range of materials. A great deal of traditional craftsmanship goes into our seats. From the seams and cushions to the superb finish, the finely honed skills of our craftsmen shine through. Not even the tiniest detail escapes their expert eye.

So that you can be sure at all times that you have purchased an original product that combines all the features of a genuine RECARO, we equip successively equip each of our seats with a special and forgery-proof hologram sticker. As a customer, this also gives you the opportunity to register your RECARO seats and become a member of the exclusive RECARO Club.



CUSTOM SEATS. TAILORED FOR PERFECTION.

A RECARO seat is like a tailor-made suit. It fits perfectly, effortlessly underlining your unique personality by combining elegance, premium quality and individual style. Only products made with passion and skill make you feel this special. Crafted to perfection using the finest materials and consistent down to the tiniest detail, they say it all.

RECARO is the brand for exclusive seats made precisely to your tastes. Alongside perfect fit, they boast intelligent design that combines the ultimate in functionality, ergonomics and looks. RECARO seats are available in a wide range of upholstery materials and colors. You can even request custom or OEM materials! We'll tailor your new seats to suit your personal preferences.



Frank Beermann
Chief Engineer Industrial Design
RECARO Automotive

"The function of a product determines its form.

As RECARO designers, our top priority is ergonomics – it's all about the person in the seat:

form follows human."

UNCONDITIONAL COMFORT.

From the heat of high summer to a frosty winter's morning, the right temperature is essential for truly comfortable seating. So RECARO came up with an ingenious system. For hot weather, the seat has a breathable membrane and air conditioning system to wick away moisture, keeping you comfortably dry, but never cold. When temperatures drop below zero, RECARO seat heating keeps you pleasantly warm.

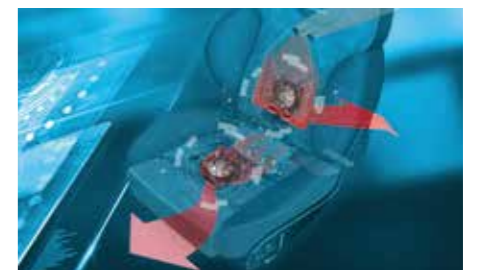

MAKE YOURSELF AT HOME.

An ergonomic sitting position also means a comfortable position. Driving your car should feel like a relaxing visit to the spa after a stressful week. With a range of smart comfort features and perfect seat contours that support your body, we make every journey an experience to savor.



“Extremely cool – when it comes to body support, the Podium does all the work. And yet it’s also unbelievably comfortable!”

Jean Pierre Kraemer
Tuner, TV presenter and CEO
of JP Performance

This support is vital, as being behind the wheel forces you to sit passively – one of the worst possible positions for your body. Depending on the route, driving style and road surface, factors like centrifugal force, deceleration and vibrations come into play, which is why many drivers complain of muscle tension, circulatory problems, headaches or concentration issues on long journeys.

A good car seat has to compensate for these factors with support and protection: an ergonomic seat structure, body-hugging contours, firm upholstery, pronounced side bolsters and finely-tuned adjustment options along with breathable covers, and comfort features such as heating or air conditioning.



**RECARO CLASSIC SEATS.
APPROVED BY WALTER RÖHRL.**

A classic car should be as original and authentic as possible. Any conversions or accessories must remain true to the era of the car’s creation. Who better to make seats for your classic car than the company that made the original seats in the first place? Also available as desk chairs!



SIT BACK AND RELAX.

You know the feeling all too well. You get into your car, eat up the miles, and arrive seized up and stressed out – just in time for the next meeting. Sitting, sitting and more sitting. With RECARO, you step out of your car feeling relaxed and ready for whatever work can throw at you, even after a long journey. That’s because our seats work around your needs.

Because we’re experts in ergonomic design

THE SEAL OF APPROVAL FOR YOUR BACK.

Mobility is synonymous with modern society. More and more people are spending more and more of their time in the car. For many drivers, it’s their workplace. The seal of quality from AGR e.V, the German Campaign for Healthier Backs, helps drivers choose back-friendly products. The RECARO Ergomed E, RECARO Style Topline XL, Sport C and the RECARO Podium carry the AGR seal.

For more information, please visit:
www.agr-ev.de/de/ratgeber-produkte/produkte/2903-autositze
www.agr-ev.de/de/ratgeber-produkte/produkte/4853-auto-rennschalen



PEAK BODY SUPPORT PERFORMANCE.

Did you ever test a RECARO seat? Then you know how good it feels. It fits like a glove. And you feel like you're sitting IN the seat and not ON it. This is what all RECARO models have in common. We call it Body Support.

With a RECARO seat where man meets machine, the road becomes a playground that gives you instant feedback all the way. It boasts a low center of gravity, firm, compact upholstery, and the necessary freedom of movement for the arms. The result: controlled cornering, and a driving

experience that you can sit back and relish. Its snug, supportive seat structure and side bolsters for excellent shoulder and torso support stabilize the body against lateral forces, cocooning it like a second skin. Feel the difference!

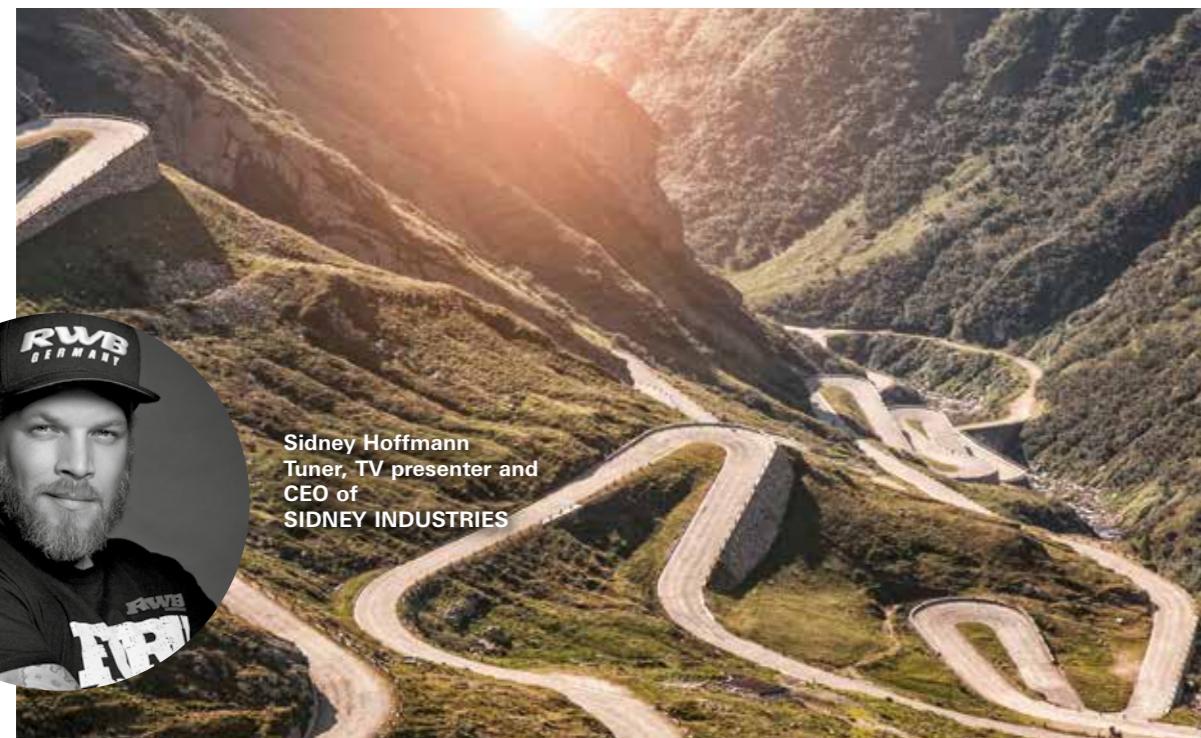

Sidney Hoffmann
Tuner, TV presenter and
CEO of
SIDNEY INDUSTRIES

"I love RECARO! The Sportster CS is the perfect symbiosis of pure racing shell and comfortable sports seat. Superb track and road performance."

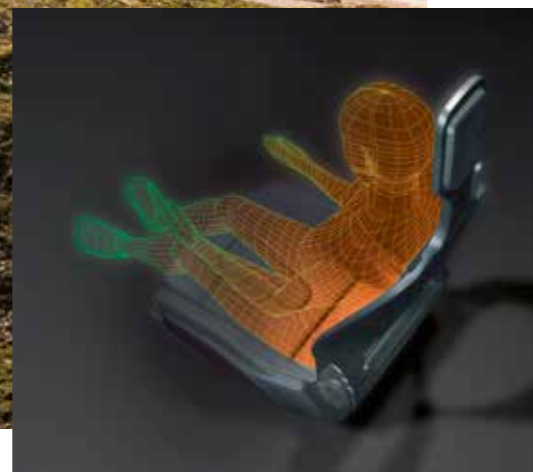

Timo Bernhard
Team Manager, Professional racing driver,
winner of American Le Mans Series and
Petit Le Mans,
2 x winner 24h Le Mans,
5 x winner 24h Nürburgring



"My RECARO racing seat is not just reassuringly safe. It's also consistently comfortable. It supports my whole body so I can perform at my very best."

DYNAMIC DRIVING EXPERIENCE.

Everything under control? The driver's seat plays a key role in this, especially if your driving style is sporty. The better your sitting position, the sharper your reactions and the more fully you have the vehicle under control. RECARO builds seats that support the body perfectly so that you can drive with greater concentration and safety. When developing sports seats for the road, we draw on our many years of experience and innovation in motorsport.



THE GO TO INDUSTRY PARTNER.

RECARO fitted as standard

With many car manufacturers, it's often worth looking at the options and equipment lists to make sure that your new car comes with RECARO seats. The international automotive industry has put its trust in RECARO from the day the brand was born. Our customers value both the renowned quality of our products and our innovative prowess. We regularly join forces with vehicle manufacturers to develop custom solutions, be it for special editions, performance vehicles or exclusive premium cars.

YOUR RECARO SEAT STARTS HERE.

DO NOT FORGET THE BASEFRAME!

Your custom RECARO seat experience is just a few steps away. Take your time and begin by asking yourself a few questions. What's crucial to me when I'm sitting in the car? What do I want from my RECARO seat? What should it look like? How does my passenger want their seat?

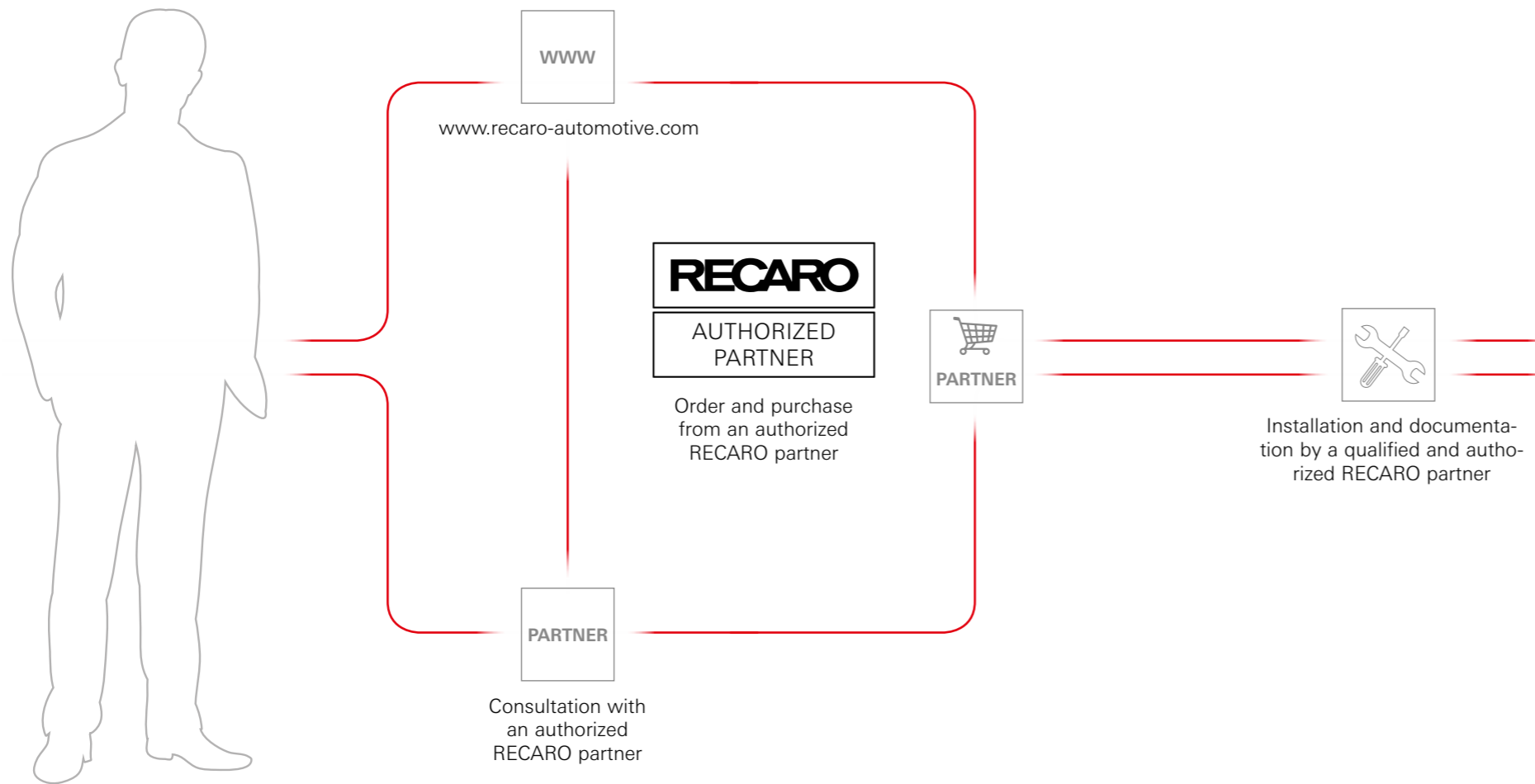

After getting an initial overview from this brochure or a visit to our website, we always recommend a personal consultation with an authorized RECARO partner. They will listen to your personal criteria and find the perfect solution. Round off your visit by trying out your favorite seat model.

Please note that the installation of RECARO seats in your car requires special baseframes to ensure a perfect, secure fit. Our partners will be happy to help.

THE RECARO SYSTEM



German general type approval (ABE)/component certification requires a RECARO baseframe or RECARO sidemounts. For special vehicles, an electric substructure with electric height, tilt and longitudinal adjustment is also available. Please consult your RECARO partner for more information.



OVERVIEW OF CAR SEAT RANGE AFTERMARKET SEATS

PREMIUM COMFORT ←

→ SPORTY PERFORMANCE



	RECARO Ergomed E	RECARO Style Topline XL	RECARO Expert S, M, L	RECARO Specialist S, M, L	RECARO Cross Sportster CS	RECARO Speed	RECARO Sportster CS	RECARO Pole Position (ABE) & Pole Position Carbon (ABE)	RECARO Sport C	RECARO Podium GF	RECARO Podium CF	
TAILORED COMFORT	Height, length, backrest, tilt adjustment, electric									●		
	Lumbar support	●	●	● Paddable	● Paddable			●	●			
	Extendable seat cushion	●	●	● M, L	● M, L				●			
	Adjustable side bolsters, backrest		●	●								
	Height adjustment, electric	●	●						●			
	Tilt adjustment, manual	●										
	Tilt adjustment, electric		●						●			
	Backrest adjustment, manual	●		●	●	●	●			●		
	Backrest adjustment, electric		●	○	○					●		
	Adjustable headrest	●	●	●	●							
	Pads M (seat for medium build drivers)										● Podium GF M	● Podium CF M
	Pads L (seat for larger build drivers)										● Podium GF L	● Podium CF L
	Seat air conditioning	○ (Climate package)	● (Climate package)								● passive	● passive
	Seat heating	○ (Climate package)	● (Climate package)	○	○					○		
	AGR certified (German Healthier Backs Campaign)	●	●							●	●	●
Easy Access			● M	● M	●							
Modular seat cushion			●	●								
XL version		●										
Backrest release, manual	●	●	●	●	●	●			○ (in development)			
SAFETY	ABE/component certification	●	●	●	●	●	●	●	●	●	●	
	Universal side airbag	○				○			○ (in development)	○ (in development)	○ (in development)	
	Suitable for 3-, 4-point belt (street use)					●	●	●	●	●	●	
	Competition Seat (FIA 8855-1999)									●	●	
	Suitable for 4-, 5-, or 6-point belt (racing use)									●	●	
	Suitable for HANS systems									●	●	
	FIA approval for 5 years									●	●	
Highly fire-resistant upholstery	●	●	●	●	●	●	●	●	●	●		
LIGHTWEIGHT CONSTRUCTION	Seat shell made from carbon and aramid (CFRP/AFRP)						○					
	Seat shell made of carbon (CFRP)										●	
	Seat shell glass fiber reinforced plastic (GFRP)						●			●		
	Composite materials					●		●	●	●	●	
Weight: complete shell (incl. foam and upholstery, without sidemount)							Pole Position (ABE) approx. 7.0 kg Pole Position Carbon (ABE) approx. 4.5 kg	approx. 24 kg		Podium GF M 11.0 kg Podium GF L 10.9 kg Net shell weight 8.5 kg (approx.)	Podium CF M 7.4 kg Podium CF L 7.3 kg Net shell weight 4.9 kg (approx.)	
SPORTY PERFORMANCE	Integrated headrest				●	●	●	●	●	●	●	
	Suitable for 4-point belts (street use)				●	●	●	●	●	●	●	
	Special lateral support in the backrest area				●	●	●	●	●	●	●	
	Special lateral support in the seat cushion area					●	●	●	●	●	●	
	Specially formed shoulder support				●	●	●	●	●	●	●	
	Dynamic ride performance				●	●	●	●	●	●	●	
	Slim design				●	●	●	●	●	●	●	

● Standard features ○ Options/Accessories

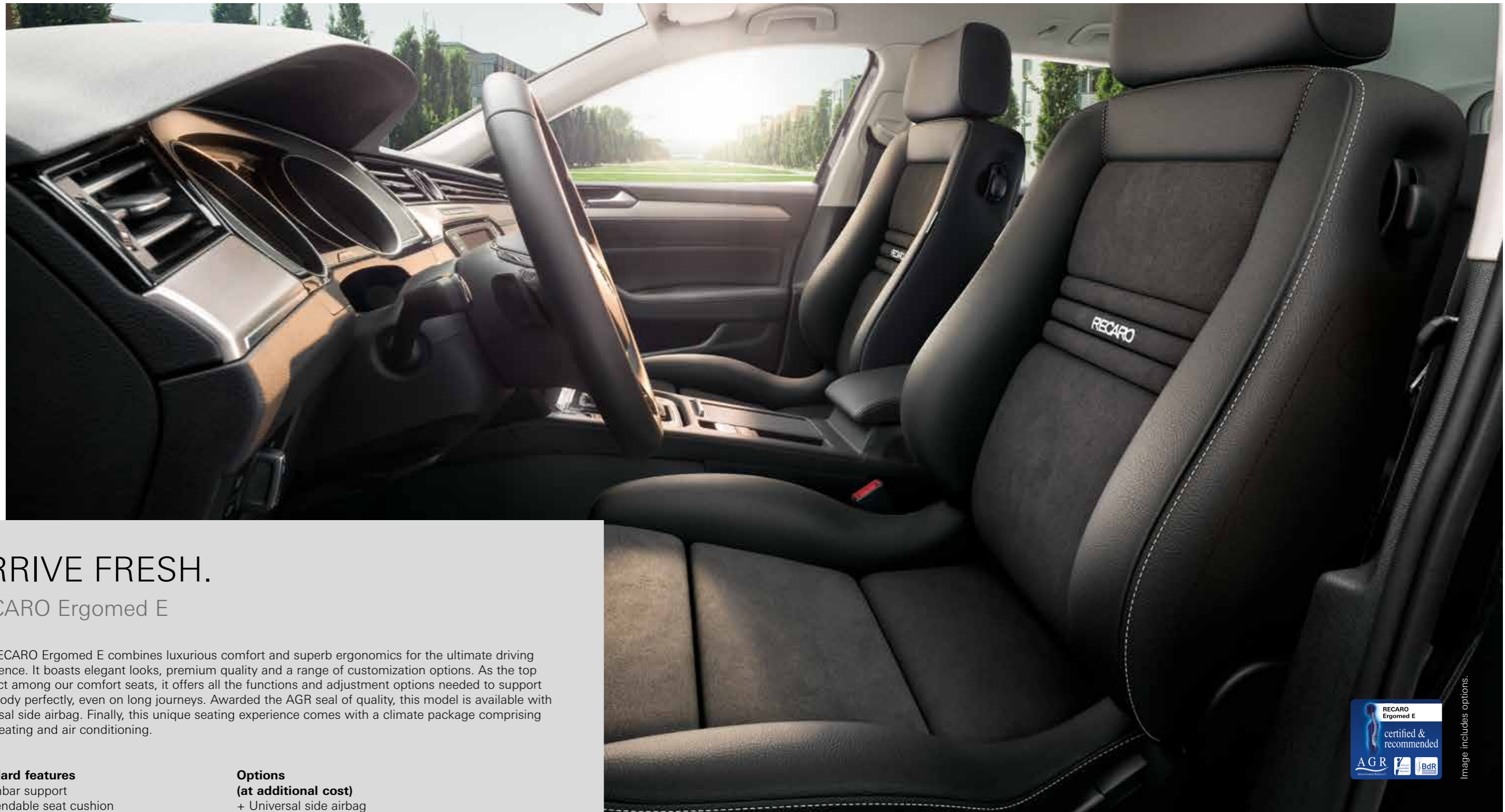

ARRIVE FRESH.

RECARO Ergomed E

The RECARO Ergomed E combines luxurious comfort and superb ergonomics for the ultimate driving experience. It boasts elegant looks, premium quality and a range of customization options. As the top product among our comfort seats, it offers all the functions and adjustment options needed to support your body perfectly, even on long journeys. Awarded the AGR seal of quality, this model is available with universal side airbag. Finally, this unique seating experience comes with a climate package comprising seat heating and air conditioning.

Standard features

- + Lumbar support
- + Extendable seat cushion
- + Backrest adjustment on both sides
- + Electric height adjustment
- + Tilt adjustment
- + Easy-to-operate switch pack
- + Backrest release on both sides
- + Adjustable headrest
- + Seatback pocket

Options

- (at additional cost)**
- + Universal side airbag
 - + RECARO climate package

Funding may be available.



Image includes options.

RECARO Ergomed E upholstery options



Nardo black
Artista black

Nardo gray
Artista gray



AGR: Approved and recommended by Healthier Backs Association (Aktion Gesunder Rücken e.V.) and the Federal Association of German Back Schools (BdR) e. V. For more information, contact: AGR e. V., Stader Str. 6, 27432 Bremervörde, Germany, Phone +49 4761 926 358 0, www.agr-ev.de/en/back-friendly-products/back-friendly-products/2903-carseats

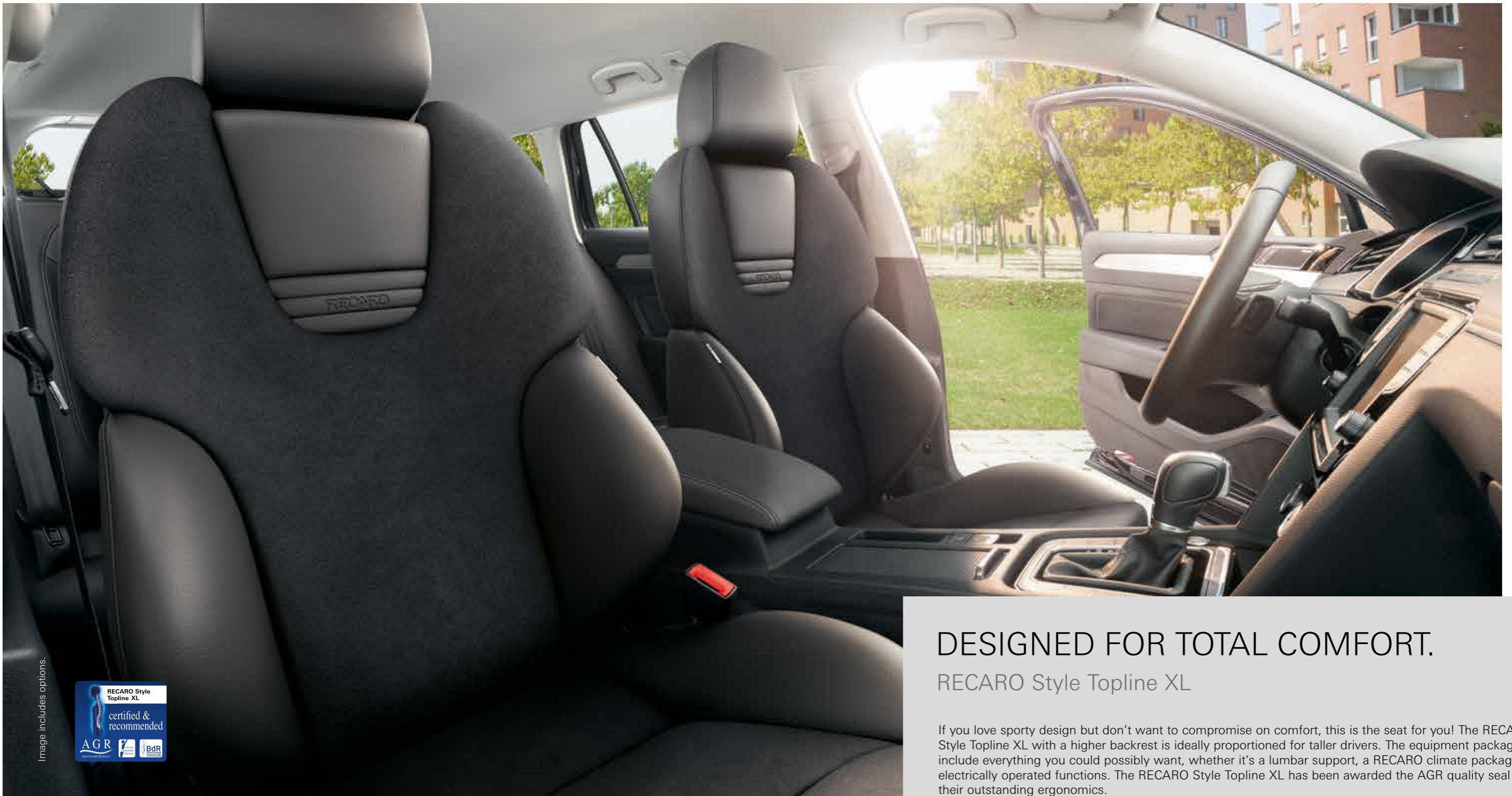

Image includes options.



DESIGNED FOR TOTAL COMFORT.

RECARO Style Topline XL

If you love sporty design but don't want to compromise on comfort, this is the seat for you! The RECARO Style Topline XL with a higher backrest is ideally proportioned for taller drivers. The equipment packages include everything you could possibly want, whether it's a lumbar support, a RECARO climate package or electrically operated functions. The RECARO Style Topline XL has been awarded the AGR quality seal for their outstanding ergonomics.

Standard features

- + Adjustable backrest side bolsters
- + Extendable seat cushion
- + Preformed backrest contour
- + Adjustable headrest
- + Backrest release on both sides
- + Lumbar support
- + Combined electric height and tilt adjustment
- + Easy-to-operate switch pack
- + RECARO climate package (heating and air conditioning)
- + Electric backrest adjustment

RECARO Style Topline XL upholstery options



Nardo black Nardo gray Leather black Leather black
 Artista black Artista gray Dinamica suede black

AGR: Approved and recommended by Healthier Backs Association (Aktion Gesunder Rücken e.V.) and the Federal Association of German Back Schools (BdR) e. V. For more information, contact: AGR e. V., Stader Str. 6, 27432 Bremervörde, Germany, Phone +49 4761 926 358 0, www.agr-ev.de/en/back-friendly-products/back-friendly-products/2903-carseats



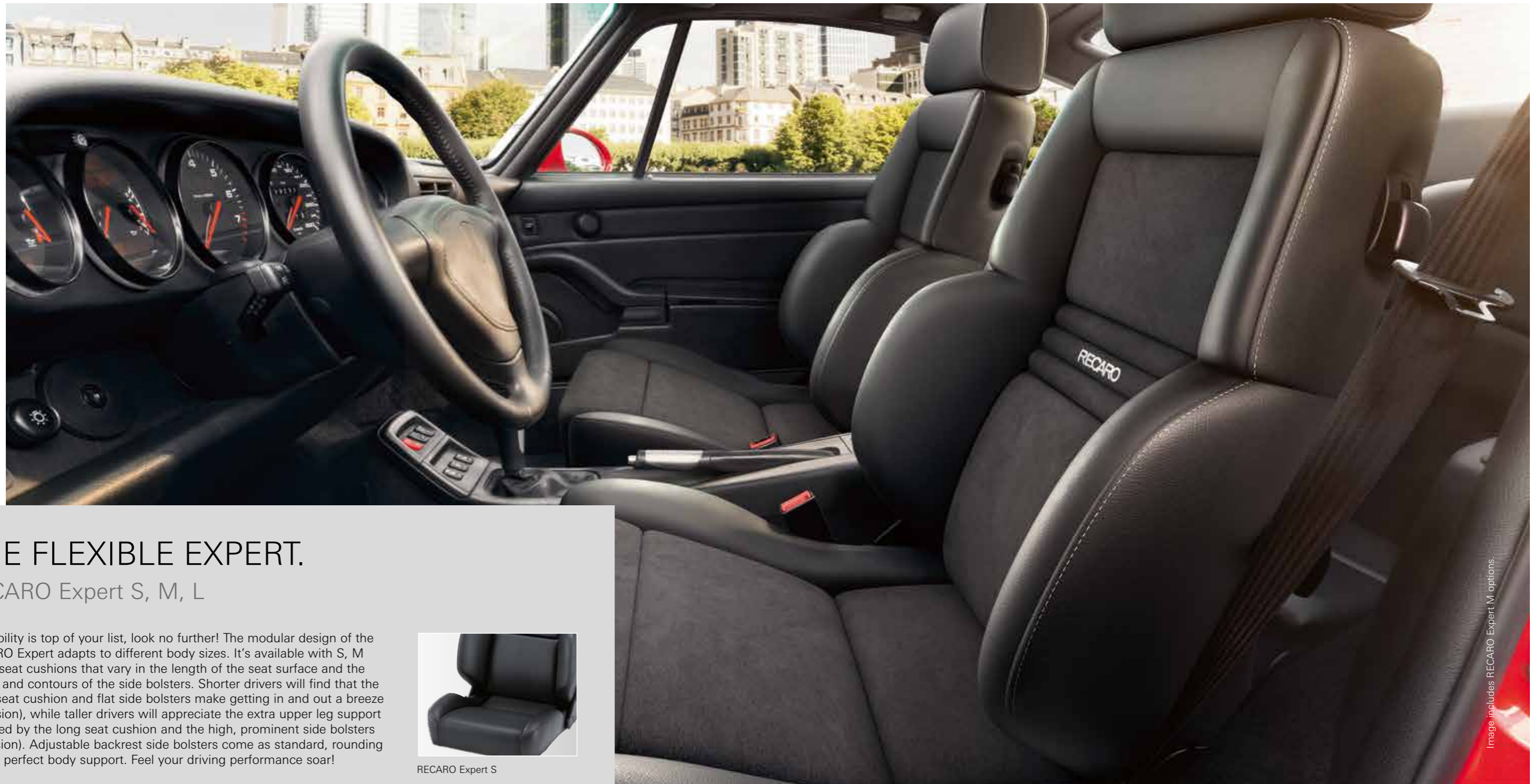

THE FLEXIBLE EXPERT.

RECARO Expert S, M, L

If flexibility is top of your list, look no further! The modular design of the RECARO Expert adapts to different body sizes. It's available with S, M and L seat cushions that vary in the length of the seat surface and the height and contours of the side bolsters. Shorter drivers will find that the short seat cushion and flat side bolsters make getting in and out a breeze (S version), while taller drivers will appreciate the extra upper leg support provided by the long seat cushion and the high, prominent side bolsters (L version). Adjustable backrest side bolsters come as standard, rounding off the perfect body support. Feel your driving performance soar!



RECARO Expert S



RECARO Expert L

Standard features

- + Paddable lumbar support
- + Preformed side bolsters
- + Backrest adjustment on both sides
- + Adjustable headrest
- + Backrest side bolsters adjustable on both sides
- + Backrest release on both sides

Options (at additional cost)

- + Seat heating

RECARO Expert S

- + Seat cushion for people of small to medium build: short seat cushion with flat side bolsters

RECARO Expert M

- + Easy Access to make it easy to get in and out
- + Seat cushion for people of medium to large build: long seat cushion with less pronounced, very flat side bolsters
- + Extendable seat cushion

RECARO Expert L

- + Seat cushion for people of medium to large build: long seat cushion with pronounced side bolsters
- + Extendable seat cushion

RECARO Expert S, M, L upholstery options



Nardo black
Artista black

Nardo gray
Artista gray

Ambla leather black
Artista black

Ambla leather black
Dinamica suede black

Ambla leather black



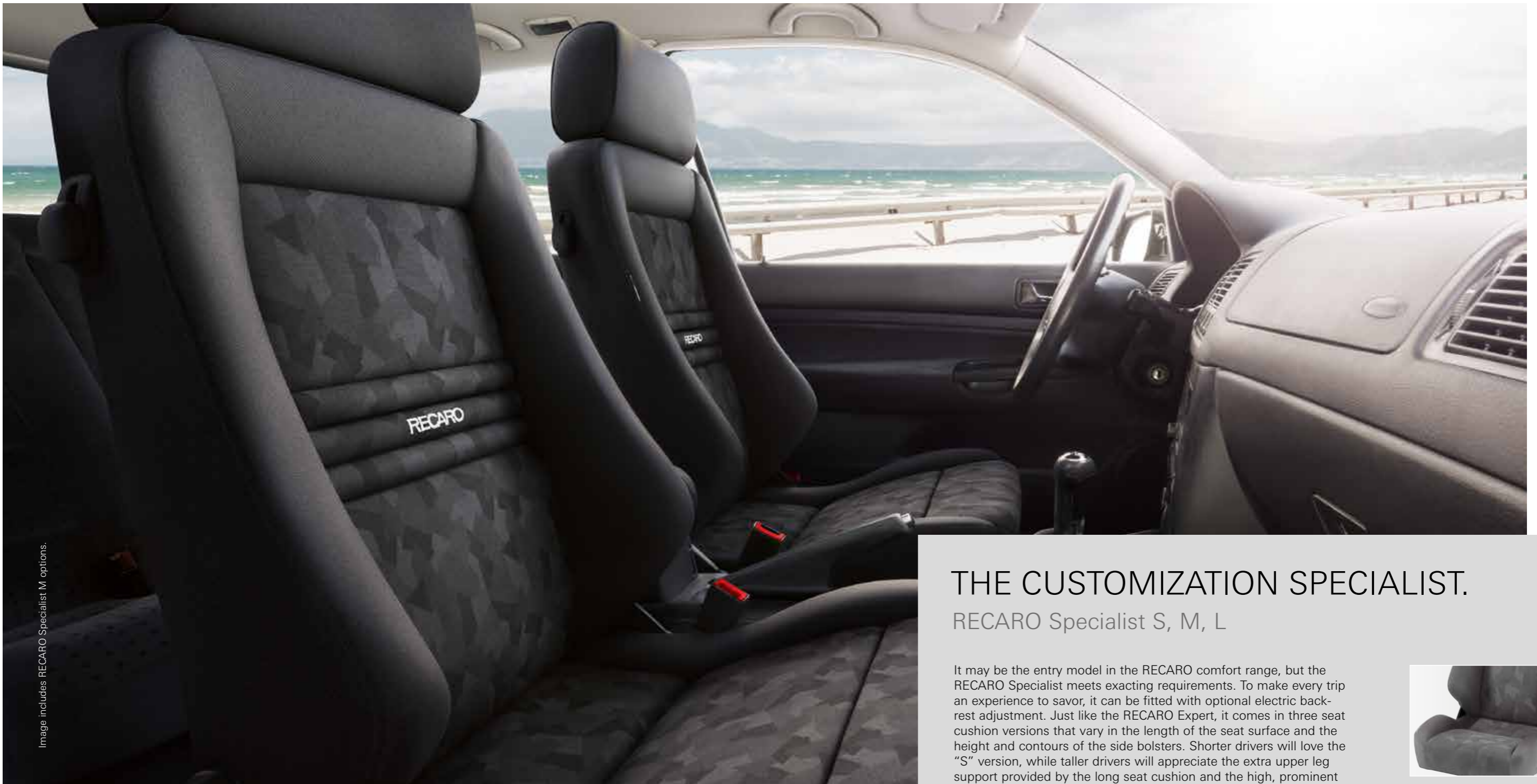

Image includes RECARO Specialist M options.

THE CUSTOMIZATION SPECIALIST.

RECARO Specialist S, M, L

It may be the entry model in the RECARO comfort range, but the RECARO Specialist meets exacting requirements. To make every trip an experience to savor, it can be fitted with optional electric backrest adjustment. Just like the RECARO Expert, it comes in three seat cushion versions that vary in the length of the seat surface and the height and contours of the side bolsters. Shorter drivers will love the "S" version, while taller drivers will appreciate the extra upper leg support provided by the long seat cushion and the high, prominent side bolsters in the "L" version.



RECARO Specialist S



RECARO Specialist L

RECARO Specialist S

- + Seat cushion for people of small to medium build: short seat cushion with flat side bolsters

RECARO Specialist M

- + Easy Access to make it easier to get in and out
- + Seat cushion for people of medium to large build: long seat cushion with less pronounced, very flat side bolsters
- + Extendable seat cushion

RECARO Specialist L

- + Seat cushion for people of medium to large build: long seat cushion with pronounced side bolsters
- + Extendable seat cushion

Standard features

- + Paddable lumbar support
- + Preformed side bolsters
- + Backrest adjustment on both sides
- + Adjustable headrest
- + Backrest release on both sides

Options

- (at additional cost)**
- + Seat heating

RECARO Specialist S, M, L upholstery options



Nardo black
Artista black
Nardo gray
Artista gray
Ambla leather black
Artista black
Ambla leather black
Dinamica suede black
Ambla leather black



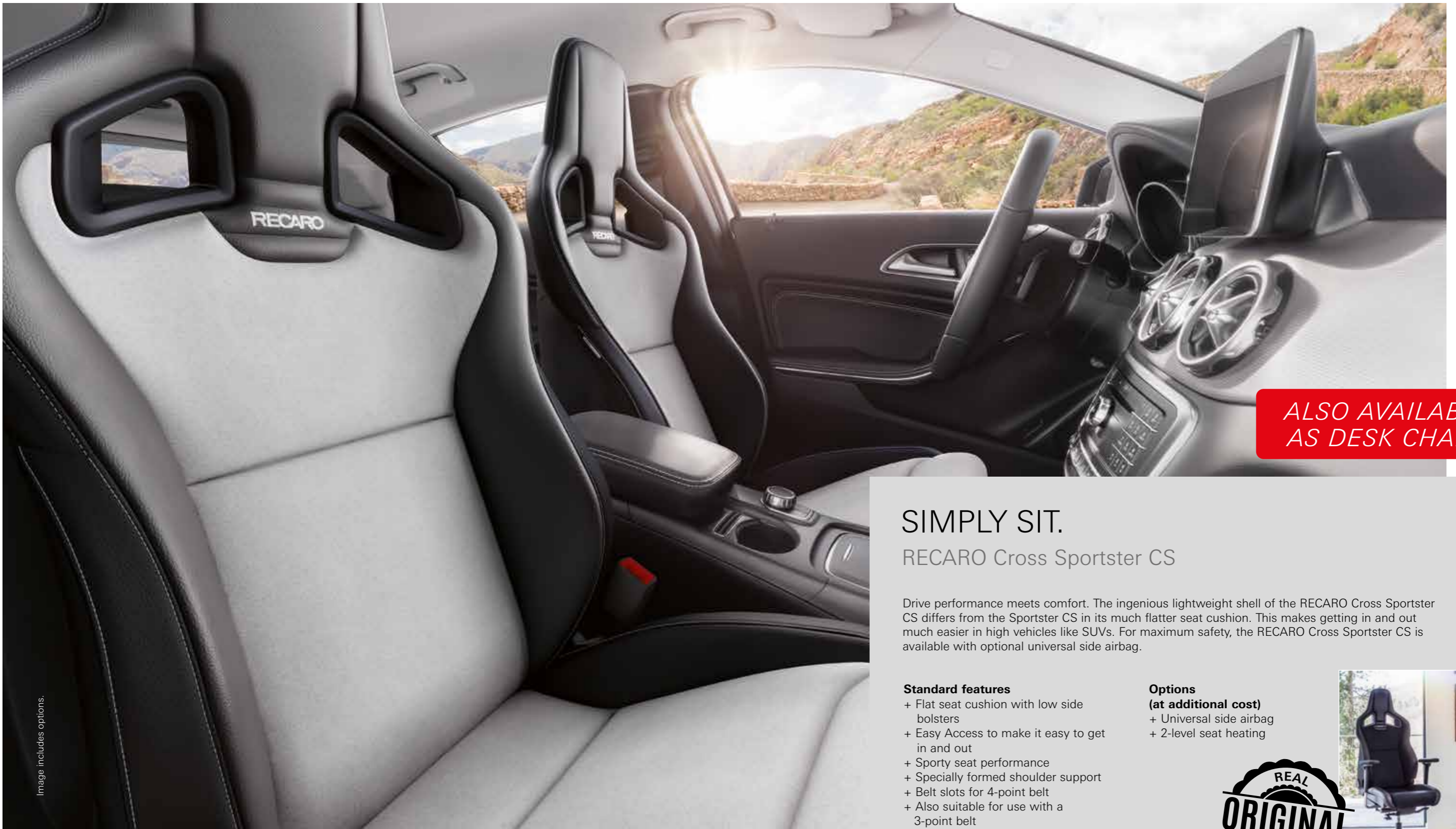

**ALSO AVAILABLE
AS DESK CHAIR!**

SIMPLY SIT. RECARO Cross Sportster CS

Drive performance meets comfort. The ingenious lightweight shell of the RECARO Cross Sportster CS differs from the Sportster CS in its much flatter seat cushion. This makes getting in and out much easier in high vehicles like SUVs. For maximum safety, the RECARO Cross Sportster CS is available with optional universal side airbag.

Standard features

- + Flat seat cushion with low side bolsters
- + Easy Access to make it easy to get in and out
- + Sporty seat performance
- + Specially formed shoulder support
- + Belt slots for 4-point belt
- + Also suitable for use with a 3-point belt
- + Backrest adjustment
- + Integrated headrest
- + Backrest release
- + Integrated sidemount

Options

- (at additional cost)**
- + Universal side airbag
 - + 2-level seat heating



RECARO Cross Sportster CS Star

RECARO Cross Sportster CS upholstery options



Nardo black
Artista black
Ambla leather black
Ambla leather black
Dinamica suede black

RECARO Cross Sportster CS with heating, upholstery options



Ambla leather black
Dinamica suede black
Ambla leather black
Dinamica suede red
Ambla leather black
Dinamica suede silver
Leather black



Image includes options.



ALSO AVAILABLE AS SWIVEL CHAIR!

DUGOUT SEATING COMFORT.

RECARO Speed

Providing firm lateral support and featuring an integrated headrest and the iconic belt slot, it is everything a genuine sports seat should be. It offers a dynamic ride in its purest form, plus an impressive, unique style! The two exclusive seat cover options consisting of robust ambla leather or genuine motorsport velour with high-quality stitching perfectly compliment the interior of any vehicle. By the way, if you're a soccer fan, you already know that the RECARO Speed is the world's most popular stadium seat for coach benches, right?

Standard features

- + Specially formed shoulder support
- + Special lateral support
- + Backrest adjustment on both sides
- + Highly pronounced side bolsters on seat cushion
- + Integrated headrest
- + Backrest release on both sides
- + Belt slots for 4-point belt
- + Also suitable for use with a 3-point belt



RECARO Speed Star

Image includes options.

RECARO Speed upholstery options



Velour black with silver stitching Ambla leather black





ELITE PERFORMANCE.

RECARO Sportster CS

A highlight of the RECARO sports seat range. The RECARO Sportster CS is the perfect combination of comfortable sports seat and pure racing shell. The innovative lightweight shell boasts an exclusive slim design, plus outstanding lateral and shoulder support. The world's best drive performance, available with optional universal side airbag. Many car manufacturers offer the Sportster CS as standard equipment in their high-performance models, such as the Ford Focus RS.

Standard features

- + Sporty seat performance
- + Racing shell look
- + Special lateral support
- + Specially formed shoulder support
- + Belt slots for 4-point belt
- + Also suitable for use with a 3-point belt
- + Backrest adjustment
- + Integrated headrest
- + Backrest release
- + Integrated sidemount

Options

- (at additional cost)**
- + Universal side airbag
 - + 2-level seat heating

Image includes options.



RECARO Sportster CS upholstery options

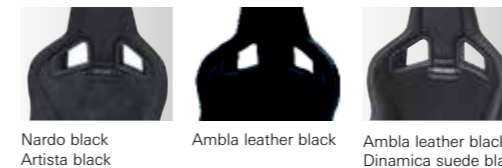

RECARO Sportster CS with heating, upholstery options





Image includes options.

THE ULTIMATE ROAD PRO.

RECARO Pole Position (ABE) & Pole Position Carbon (ABE)

A thoroughbred racing shell licensed for a sporty ride on the open road. Tried and trusted by the world's most famous secret agent! The RECARO Pole Position (ABE) is the ultimate track-road crossover seat. With a one-piece shell made of carbon aramid (CFRP/AFRP) or glass fiber reinforced plastic (GFRP) and flawless ergonomics, no wonder it has a long-standing track record as one of club motorsport's most popular racing shells. Many exclusive car manufacturers upgrade their top performance models with the Pole Position.

Standard features

- + Belt slots for 4-point belt
- + Also suitable for use with a 3-point belt
- + Integrated headrest
- + ABE (German general type approval) component certification**
- + Paddable lumbar support

Accessories

(at additional cost)

- + Aluminum sidemount
- + Steel sidemount

**** Seat with ABE (German general type approval)/component certification with 3-point belt available for many vehicles.**

For further information on specific vehicles, please contact an authorized RECARO partner (ABE/component certification only in conjunction with RECARO baseframe and sidemount).



RECARO Pole Position (ABE)

- + Standard features
- + Glass fiber reinforced plastic (GFRP) seat shell
- + Weight approx. 7.0 kg (without sidemount and baseframe)

RECARO Pole Position Carbon (ABE)

- + Standard features
- + Carbon aramid (CFRP/AFRP) seat shell
- + Weight approx. 4.5 kg (without sidemount and baseframe)

RECARO Pole Position (ABE) upholstery options



Velour black Nardo black Ambla leather black Ambla leather black Ambla leather black Leather black
Artista black Dinamica suede red Dinamica suede black

RECARO Pole Position Carbon (ABE) upholstery options



Velour black Leather black

Accessories



Aluminium sidemount Steel sidemount



WORLD FIRST

THE FIRST ALL-ELECTRIC 8-WAY AFTERMARKET SPORTS SEAT.

RECARO Sport C

The new RECARO Sport C embodies everything about the RECARO brand: performance, quality, innovation, safety and comfort. And our passion for sporty cars and outstanding craftsmanship. The result is a unique sports seat designed for a very special driving experience. Its pioneering design, combined with all-electric adjustments and superior body support, will wow car enthusiasts while also delivering premium performance the like of which the aftermarket has never seen. The one and only new RECARO Sport C.

Image includes options.



AGR: Approved and recommended by Healthier Backs Association (Aktion Gesunder Rücken e.V.) and the Federal Association of German Back Schools (BdR) e. V. For more information, contact: AGR e. V., Stader Str. 6, 27432 Bremervörde, Germany, Phone +49 4761 926 358 0, www.agr-ev.de/en/back-friendly-products/back-friendly-products/4853-car-racing-shells



Image includes options.

RECARO Sport C

The first model in RECARO's new generation of sports seats: Where man meets machine, it gives you instant feedback. With a low center of gravity, firm, compact upholstery, and the necessary freedom of movement for the arms, the RECARO Sport C helps you keep control on corners and truly enjoy the experience of driving. And with RECARO's hallmark ultra-slim backrest contour – designed with both aesthetics and comfort in mind – passengers in the back seat will relish all the extra legroom. With a whole range of electric adjustment options, premium car owners can totally indulge in their new seats.

Standard features

- + All-electric 8-way adjustment*: backrest, fore-and-aft adjustment, seat height, seat angle
- + Easy-to-operate switch pack
- + Ultra-slim design
- + Very low hip point**
- + Fully upholstered headrest as standard
- + Sporty side bolsters in backrest and on seat bottom
- + Belt slots for 4-point belt
- + Also suitable for use with a 3-point belt
- + Specially formed shoulder support

- + Extendable seat cushion
- + Lumbar support (4-way)
- + Lightweight: only approx. 24 kg per seat
- + Innovative structure for maximum safety

Options (at additional cost)

- + 2-level seat heating
- + Backrest release (for 2/3 door cars), (in development)
- + Additional seat cover options
- + Side airbag (in development)



RECARO Sport C upholstery options



Leather white
Dinamica suede black Leather black
Dinamica suede black Dinamica suede grey/
decorative rally strips
(in development) Leather black
(in development)



* All-electric 8-way adjustment:

- Backrest: adjustable 15° forwards, 45° backwards
- Fore-and-aft adjustment: 240 mm
- Height adjustment: 60 mm
- Tilt adjustment: 6°

** Hip point: 155 mm

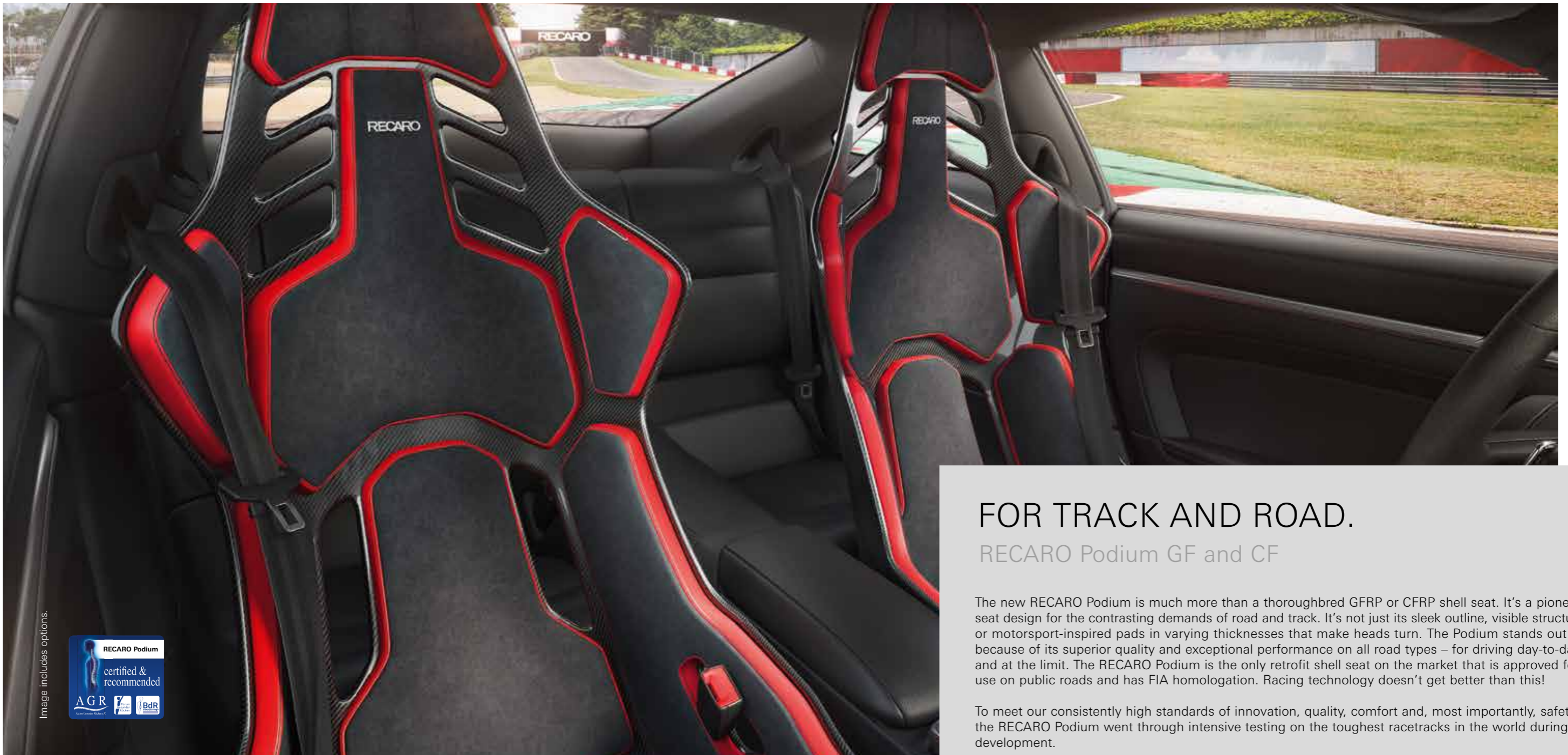

Image includes options.



FOR TRACK AND ROAD.

RECARO Podium GF and CF

The new RECARO Podium is much more than a thoroughbred GFRP or CFRP shell seat. It's a pioneering seat design for the contrasting demands of road and track. It's not just its sleek outline, visible structures or motorsport-inspired pads in varying thicknesses that make heads turn. The Podium stands out because of its superior quality and exceptional performance on all road types – for driving day-to-day and at the limit. The RECARO Podium is the only retrofit shell seat on the market that is approved for use on public roads and has FIA homologation. Racing technology doesn't get better than this!

To meet our consistently high standards of innovation, quality, comfort and, most importantly, safety, the RECARO Podium went through intensive testing on the toughest racetracks in the world during development.

The suave combination of original Alcantara® fabrics and exclusive leather together with the passive ventilation of the open back shell and airy pad contours make even the longest of routes the most perfect of pleasures. In addition, the RECARO Podium is the first racing shell ever to be awarded the coveted seal of quality from AGR e.V., the German Campaign for Healthier Backs – a reliable decision-making aid when buying back-friendly products. The shell is also super light – but, of course, that goes without saying.

RECARO Podium GF/CF M for medium build drivers

The RECARO Podium M is suitable for medium build drivers. The approx. **20 mm** thick pads are available in all of the listed cover options.

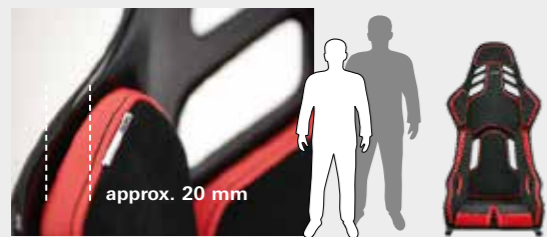

RECARO Podium GF/CF L for larger build drivers

The RECARO Podium L is suitable for larger build drivers. The approx. **10 mm** thick pads are available in all of the listed cover options.

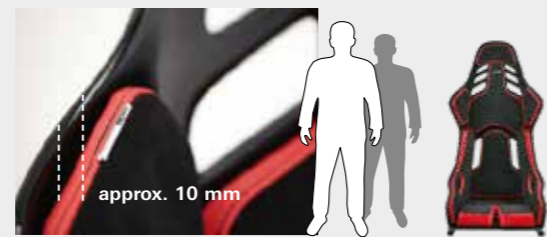

AGR: Approved and recommended by Healthier Backs Association (Aktion Gesunder Rücken e.V.) and the Federal Association of German Back Schools (BdR) e. V. For more information, contact: AGR e. V., Stader Str. 6, 27432 Bremervörde, Germany, Phone +49 4761 926 358 0, www.agr-ev.de/en/back-friendly-products/back-friendly-products/4853-car-racing-shells

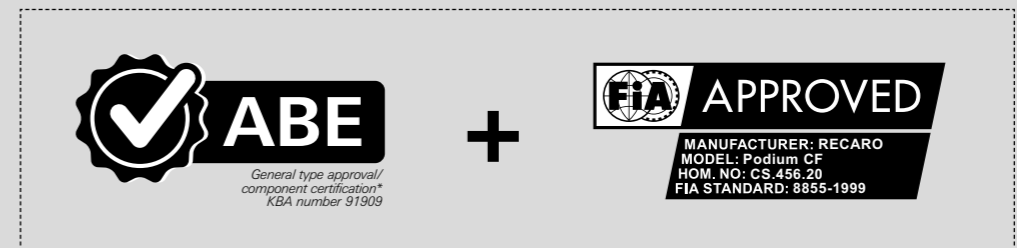



RECARO Podium GF (Glass fiber reinforced plastic GFRP)



Standard features

- + Glass fiber reinforced plastic (GFRP) seat shell
- + RECARO Podium GF **M**: with pads for medium build drivers
- + RECARO Podium GF **L**: with pads for larger build drivers
- + ABE and FIA homologation
- + Suitable for track and road
- + Sporty seat performance
- + Sleek racing seat look
- + Special lateral support
- + Specially formed shoulder support
- + Integrated headrest
- + High-grade surface in mirror-finish black gelcoat
- + Road use: with 3- or 4-point belt
- + FIA: with 4-, 5- or 6-point belt

- + Developed for the use of HANS systems¹
- + **One of the lightest seats in the world²:**
 RECARO Podium GF L: approx. 10.9 kg
 RECARO Podium GF M: approx. 11.0 kg (including pads in black velour)
- + Net seat weight: only approx. 8.5 kg

Options (at additional cost)

- + Seat cover options with Alcantara®/leather
- + Side airbag³ (in development)

Accessories (at additional cost)

- + Sidemount Podium GF, ABE, FIA
- + Pad Kit M and L in three cover options

*** Seat with ABE (German general type approval)/component certification with 3-point belt available for many vehicles.**
 For further information on specific vehicles, please contact an authorized RECARO partner (ABE/component certification only in conjunction with RECARO baseframe and sidemount).
**** FIA homologation 8855-1999** only in conjunction with the specified sidemount.



ALCANTARA

RECARO Podium GF Seat cover options

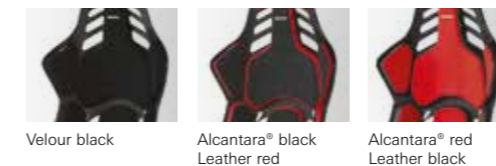

Velour black

Alcantara® black
Leather red

Alcantara® red
Leather black

Accessories



Sidemount Podium GF, ABE, FIA



Pad Kit M/L
Velour black

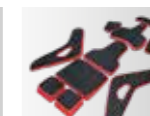

Pad Kit M/L
Alcantara® black
Leather red



Pad Kit M/L
Alcantara® red
Leather black

¹ Temporary removal of pad and pad pins recommended.

² One of the lightest seats in its class: category retrofit seats with road approval and FIA approval.

³ No FIA approval if used with a side airbag.



**LIGHTEST SEAT
IN THE WORLD¹**

RECARO Podium CF (Carbon fiber reinforced plastic CFRP)

Standard features

- + Carbon fiber reinforced plastic (CFRP) seat shell
- + RECARO Podium CF **M**: with pads for medium build drivers
- + RECARO Podium CF **L**: with pads for larger build drivers
- + ABE and FIA homologation*/**
- + Suitable for track and road
- + Sporty seat performance
- + Sleek racing seat look
- + Special lateral support
- + Specially formed shoulder support
- + Integrated headrest
- + Visible seat structures
- + Road use: with 3- or 4-point belt
- + FIA: with 4-, 5- or 6-point belt
- + Developed for the use of HANS systems²

+ Lightest seat in the world¹:

- RECARO Podium CF L: approx. 7.3 kg
- RECARO Podium CF M: approx. 7.4 kg (incl. pads in velour black)
- + Net seat weight: only approx. 4.9 kg

Options (at additional cost)

- + Seat cover options with Alcantara®/leather
- + Side airbag³ (in development)

Accessories (at additional cost)

- + ABE sidemount
- + FIA sidemount
- + Sidemount Podium CF, ABE
- + Pad Kit M and L in three cover options

*** Seat with ABE (German general type approval)/component certification with 3-point belt available for many vehicles.**

For further information on specific vehicles, please contact an authorized RECARO partner (ABE/component certification only in conjunction with RECARO baseframe and sidemount).

**** FIA homologation 8855-1999** only in conjunction with the specified sidemount.



ALCANTARA

RECARO Podium CF Seat cover options

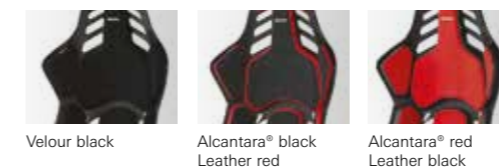

Velour black

Alcantara® black
Leather red

Alcantara® red
Leather black

Accessories



ABE sidemount

FIA sidemount

Sidemount Podium
CF, ABE

Pad Kit M/L
Velour black

Pad Kit M/L
Alcantara® black
Leather red

Pad Kit M/L
Alcantara® red
Leather black

¹ One of the lightest seats in its class: category retrofit seats with road approval and FIA approval.

² Temporary removal of pad and pad pins recommended.

³ No FIA approval if used with a side airbag.



RECARO UPHOLSTERY MATERIALS

Nardo:
In combination with the Artista upholstery, this ultra-durable material keeps your side bolsters in perfect shape for a very long time.

Nardo gray
Nardo black

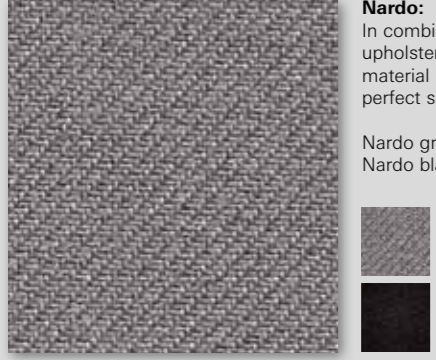

Artista:
A timelessly elegant fabric for a refined interior. Guarantees longevity and durability.

Artista gray
Artista black



Velour:
A robust, easy-care fabric which is also used to upholster RECARO motorsport racing shells.

Velour black

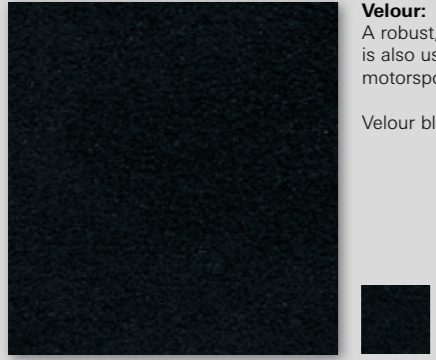

Dinamica suede:
This exclusive upholstery is highly durable and easy-care with a premium feel. The material is also breathable, vegan, light, and even hypoallergenic.

Dinamica suede red
Dinamica suede silver
Dinamica suede black
Dinamica suede grey

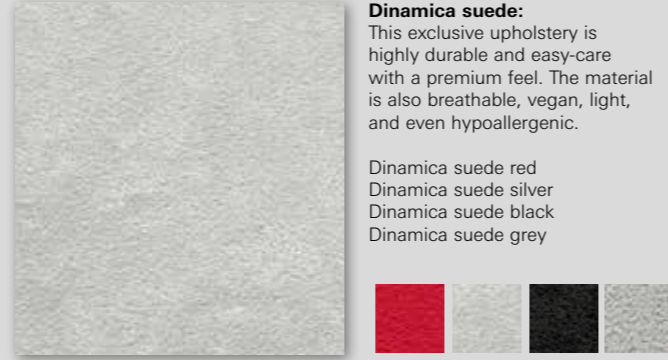

Ambra leather:
RECARO Ambra leather is a high-quality, highly durable easy-care alternative to leather.

Ambra leather black



Alcantara®:
Alcantara is a Carbon Neutral material made in Italy which offers an unparalleled combination of aesthetic, technical and sensory qualities. It is elegant, soft but also breathable, light and wear resistant, able to turn car interiors into exclusive and special environments.

Alcantara black
Alcantara red



Leather:
RECARO leather is a high-quality natural product designed for exacting requirements.

Leather black
Leather red
Leather white

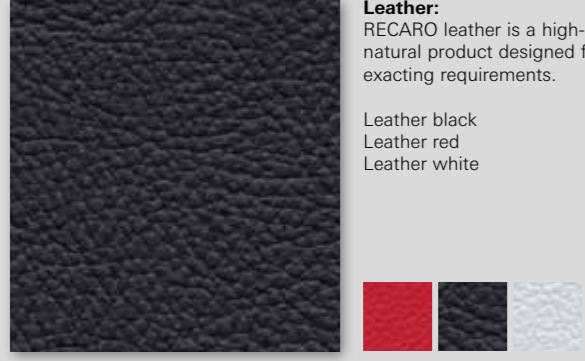

Notes: Customers may provide their own bespoke upholstery materials. These must be suitable and approved for use in the automotive sector. The seat air conditioning and heating functions may be restricted as a result. For seats with a side airbag we recommend that you contact an approved consultant in advance. Current seat upholstery from selected automotive manufacturers is available on request (restrictions apply).

RECARO SEATING TRAINING

1

Push your bottom as near as possible to the backrest. Adjust the distance from the seat to the pedals so that your knee is slightly bent when the pedals are fully depressed.

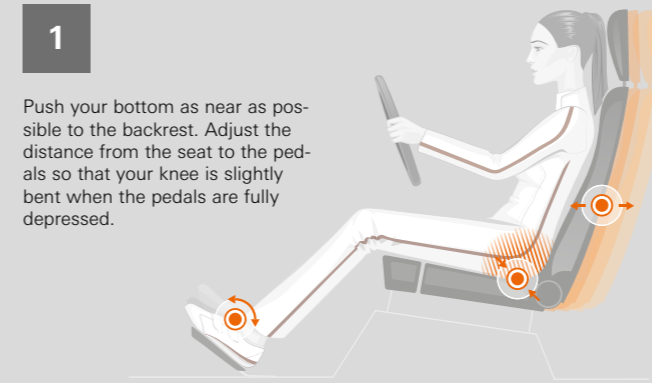

2

Rest your shoulders as near as possible to the backrest. Set the backrest tilt so that the steering wheel is easy to reach with slightly bent elbows and your shoulders stay in contact when turning the wheel.

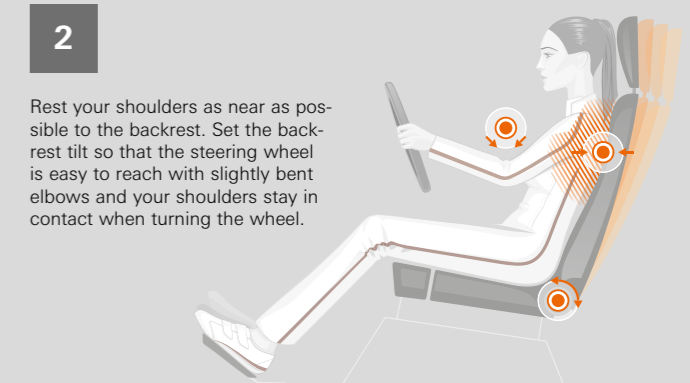

3

Set the seat height as high as possible for an unobstructed view of all sides and all the instrument panel displays.

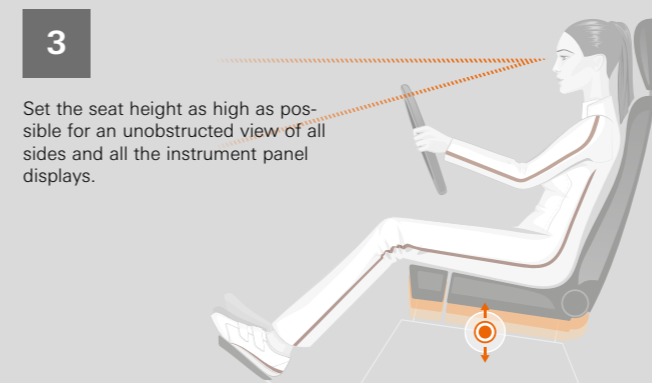

4

Set the seat cushion tilt so that it is easy to fully depress the pedals. Your thighs should rest gently on the seat cushion without exerting pressure on it. Check the backrest tilt before starting the engine.

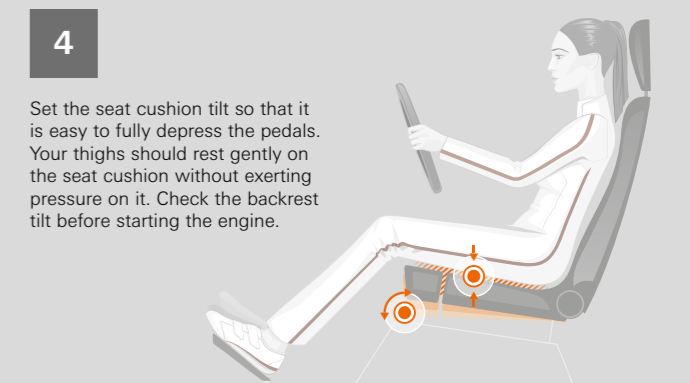

5

Adjust the extendable seat cushion so that your thighs rest on it to just above the knee. The rule of thumb is two to three fingers' clearance between the seat edge and the hollow of the knee.

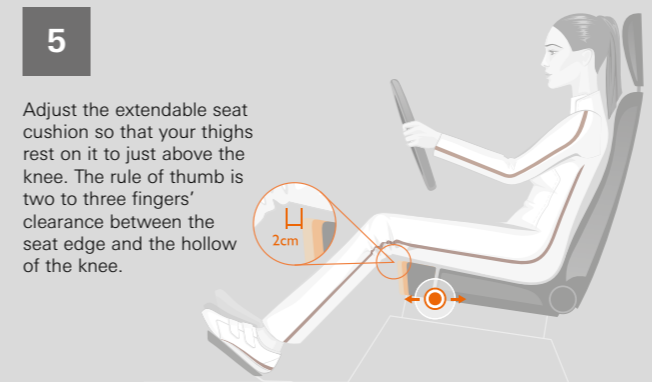

6

The lumbar support has been adjusted correctly when it supports the natural curve of your lumbar spine.

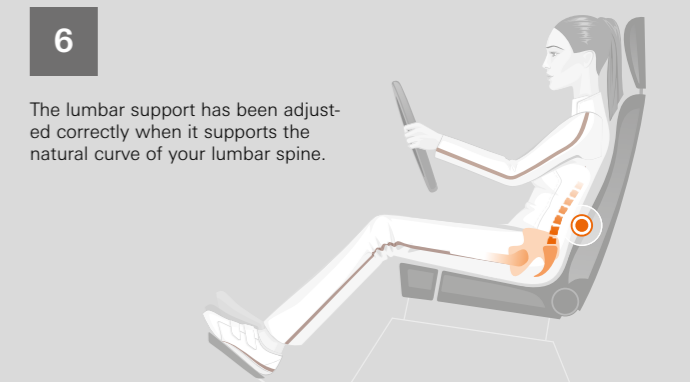

7

The seat's side bolsters should fit snugly enough to support your upper body at the side without restricting it.

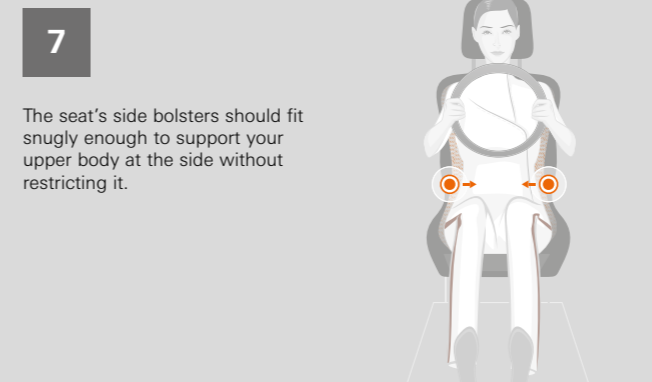

8

If possible, adjust the upper edge of the headrest to the same height as the top of your head. Tilt: The distance to your head should be approx. 2 cm.

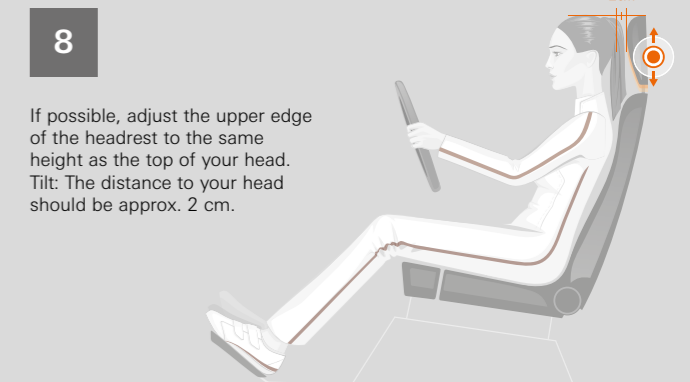

RECARO COMFORT DIMENSIONS

At RECARO, people are the focal point. With this in mind, here are some comfort dimensions to help you find the seat that's right for you. Comfort dimensions are the size factors that you feel when you're behind the wheel, and that have a direct influence on your comfort and performance. They are vital for comfortable sitting. But everyone is different

and has different preferences when it comes to comfort. We recommend testing our seats thoroughly at a RECARO service partner before buying.

The comfort dimensions are measured on the upholstery and seams. Small deviations cannot be excluded.

RECARO Ergomed E

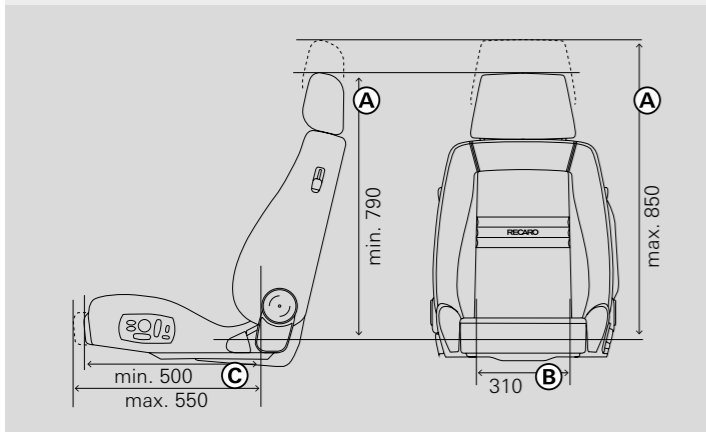

RECARO Style Topline XL

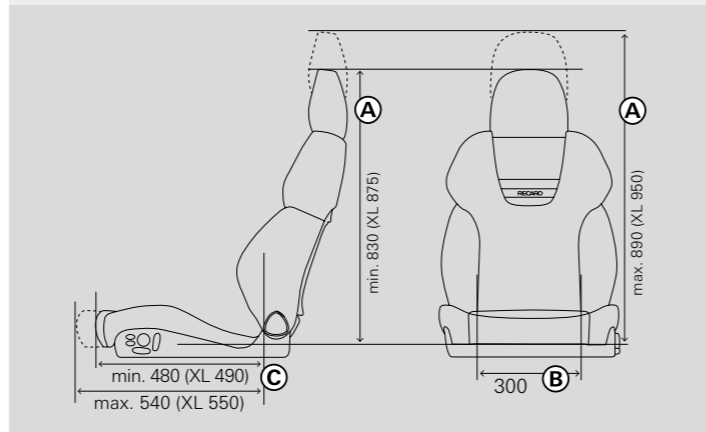

RECARO Sportster CS



RECARO Pole Position (ABE) and Pole Position (ABE) Carbon



RECARO Expert S, M, L

(drawing shows Expert S)

Seat dimensions

RECARO Expert M:

- A** Min. 790 mm
Max. 845 mm
- C** Min. 510 mm
Max. 555 mm

RECARO Expert L:

- A** Min. 790 mm
Max. 845 mm
- C** Min. 485 mm
Max. 530 mm

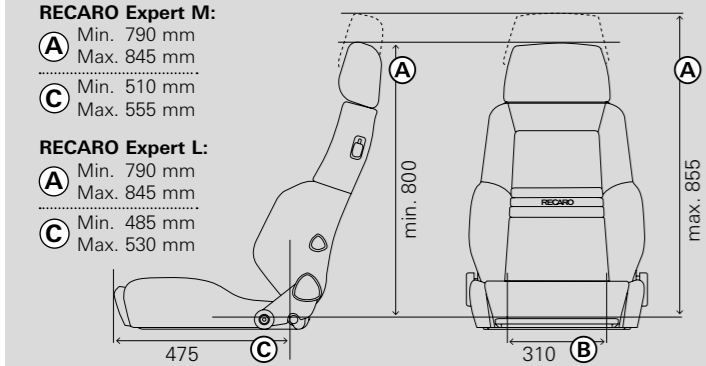

RECARO Specialist S, M, L

(drawing shows Specialist S)

Seat dimensions

RECARO Specialist M:

- A** Min. 790 mm
Max. 845 mm
- C** Min. 510 mm
Max. 555 mm

RECARO Specialist L:

- A** Min. 790 mm
Max. 845 mm
- C** Min. 485 mm
Max. 530 mm

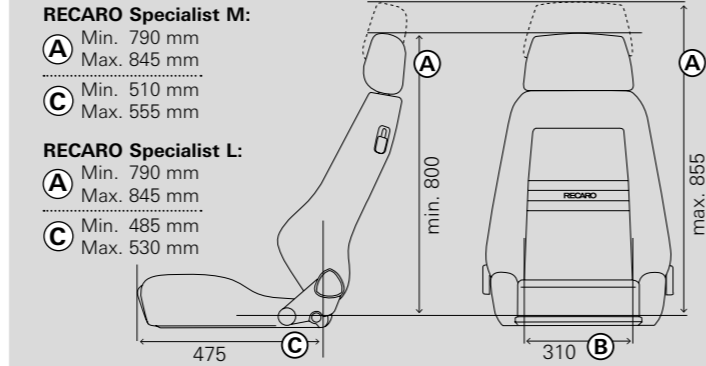

RECARO Sport C

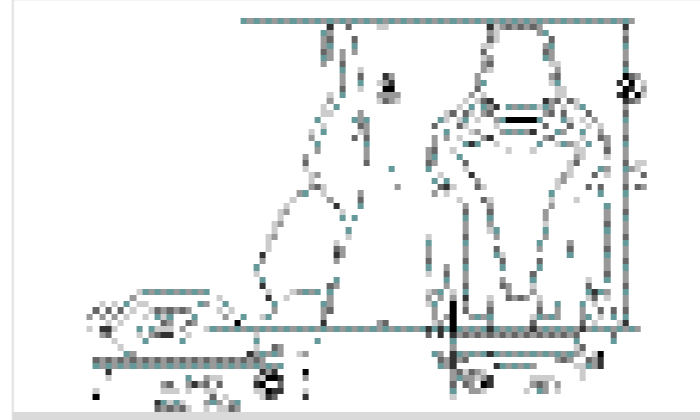

RECARO Podium GF and Podium CF

Seat dimension (B)

- RECARO Podium GF/CF M:** 358 mm
- RECARO Podium GF/CF L:** 378 mm

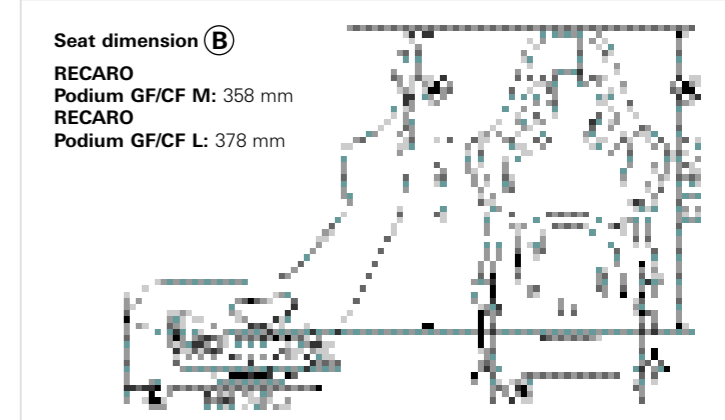

RECARO Cross Sportster CS

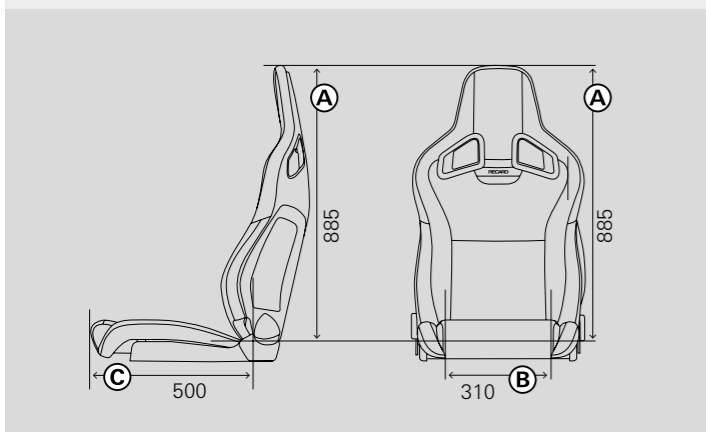

RECARO Speed



KEY

Comfort dimensions:

- A:** Seat height
 - B:** Seat width
 - C:** Seat depth
- Dimensions in mm, all dimensions ±10 mm

- Seats with adjustable backrest were measured at a backrest angle of 73–74°.
- The **seat height** indicates the vertical height of the backrest from the top of the headrest to the top of the seat cushion.
Seats with adjustable headrest: Minimum dimension with retracted headrest. Maximum dimension with fully extended headrest.
- The **seat width** indicates the width of the seat cushion without side bolsters. This dimension was measured 12 cm in front of the bottom of the backrest.
- The **seat depth** indicates the total horizontal length of the seat cushion (from the front of the cushion to the bottom of the backrest).
Seats with extendable seat cushion: Minimum dimension with retracted seat cushion. Maximum dimension with fully extended seat cushion.

FOR TRUE FANS OF THE BRAND: RECARO AUTOMOTIVE LIFESTYLE.

You know that feeling you get with RECARO of owning something special? Well you can now experience that feeling beyond your car: With the RECARO Lifestyle Collection, we are bringing our dynamic, high-performance brand directly from the road and the racetrack right into your home! Visit our online shop for collections and high-quality products to suit every taste















BUY DIRECTLY ONLINE

shop.recaro-automotive.com

RECARO SYMBOLS







TAILORED COMFORT

 Lumbar support	 Extendable seat cushion	 Adjustable side bolsters	 Height adjustment
 Tilt adjustment	 SEATING Seat heating	 AC AIRCOND. Heating and air conditioning (RECARO climate package)	 XL XL seat – ideal for people of large build
 EASY ACCESS Flat seat cushion for getting in and out with ease	 Replacable pads (M/L), individually adjustable to the driver's build	 Passive seat air conditioning	 electric fore-aft adjustment

LIGHTWEIGHT CONSTRUCTION

 LIGHT WEIGHT Seat made of lightweight, environmentally friendly composite materials	 CFRP Seat shell made of carbon fiber reinforced plastic	 CFRP AFRP Seat shell made of carbon and aramid fiber reinforced plastic	 GFRP Seat shell made of glass fiber reinforced plastic
---	--	--	---

SAFETY

 AIR BAG Available with optional universal side airbag	 ROAD 3-/4- POINT BELT Suitable for 3- and 4-point belt	 RACE 4-/5-/6- POINT BELT Suitable for 4-, 5- und 6-point belt	 ABE Seat with ABE (German general type approval)/ component certification
 COMPETITION SEAT 5 YEARS FIA-Homologation für 5 Jahre	 HANS Racing seat optimized for the HANS system		

USE

 GT SPORT Seat for GT vehicles	 TOURING SPORT Seat for touring cars
---	--



FIA-approved racing seat or sidemount.

The new 'FIA Approved' logo indicates which product from the respective manufacturer is approved under which official homologation number according to the FIA standard.

MANUFACTURER: Information about the manufacturer
MODEL: Product designation
HOM. NO: Number under which the product is homologated
FIA STANDARD: Information about the approved FIA standard

NOTES: FIA-Homologation 8855-1999

- The dimensions of the racing seat RECARO Podium were determined in standard position (upper mounting point at front and lower mounting point at rear).
- The RECARO Podium racing shell can be installed individually in all racing cars. It is also approved in the StVZO (ABE) area.
- FIA homologation 8855-1999 only in combination with the associated sidemount.
- The RECARO motorsport seats are made by hand to our highest quality standards. Due to this special manufacturing process, the lamination may in exceptional instances result in slight tolerances to the specified dimensions and weights.

RECARO Automotive
 Stuttgarter Strasse 73
 73230 Kirchheim/Teck
 Germany

Phone: +49 7021 93-5000

E-mail: info@recaro-automotive.com
 Internet: www.recaro-automotive.com
 shop.recaro-automotive.com

